

Architectural Series | Series 704

SlideMASTER™ Sliding Door (Internal Sliding)

Overview

The Series 704 is a high performance internal sliding commercial door offering up to 4 panels in each direction.

Key Features

- This high performance sliding door has been tested for compliance with the relevant Australian Standards. Achieved a very high water resistance of 450Pa.
- The extra strong multi-hollow meeting stiles allow large sliding doors to be fabricated in high wind load areas.
- There are a large variety of door combinations possible:
XF, FX, FXF, FXXF, XXF, FX and FXXXXF.
90° corner units FX^XF and FXX^XXF also available.
- The door is compatible with the high performance Series 406 606 (single glazed) and 426 / 626 (double glazed) FrontGLAZE™ framing. The head and jamb sections have an additional weather leg to ensure that junctions between doors and fixed sidelights/highlights maintain the high water resistance.
- Doors can be fitted with surface mounted deadlock, mortice lock or multi point mortice lock.
- Doors run on heavy duty double bogey wheel carriages. The key to silent running door is to match the wheel diameter to the running track. This shares the dead load across the track. This is why our doors slide smooth and quiet. If required the height of the wheel can be adjusted from the edge of the panel with a standard 'Phillips' screw driver.
- Variety of bottom rail and mid rail sizes available. The tall square bottom rail is standard and illustrated on back page.
- Custom aluminium sub-sills with built-in anti blow-back drainage hole cover flap are always fitted under SlideMASTER™ sliding doors.
- Door panels will accept glass up to 13.52mm thick single glazed or 20mm and 24mm double glazed IGU's using special rails and stiles.
- Thresholds and snap-in flat filler ensure that the clean looks are maintained.
- Can also be fitted with concealed roller screens or sliding fly doors. Both systems are illustrated on back page.

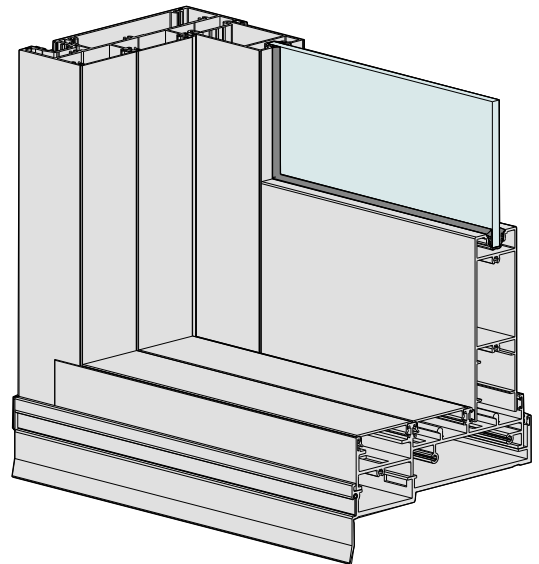

Maximum Panel Height	3000mm
Maximum Panel Width	2500mm
Maximum Glass Thickness	≤ 24mm

Subject to individual site conditions. Contact AWS Technical Support for information.



WERS RATED PRODUCT



ENHANCED ACOUSTIC PERFORMANCE



3D & 2D CAD FILES AVAILABLE



PRODUCT INFORMATION AVAILABLE AT
WWW.ELEVATEALUMINIUM.COM.AU



SPECIFIER ASSISTANCE AVAILABLE

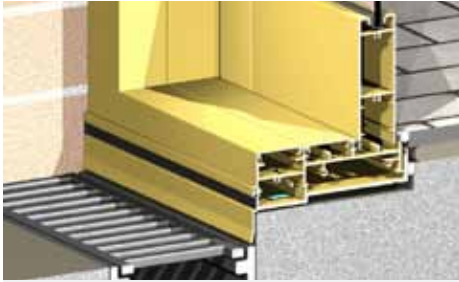

A unique, self draining sub sill is a feature of the 704.

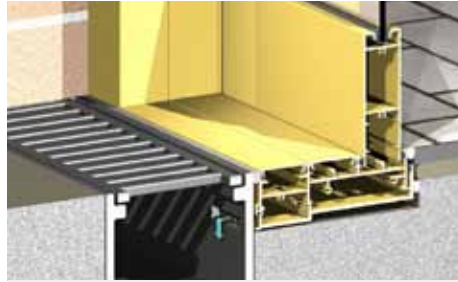

Sills can be installed flush between internal and external.

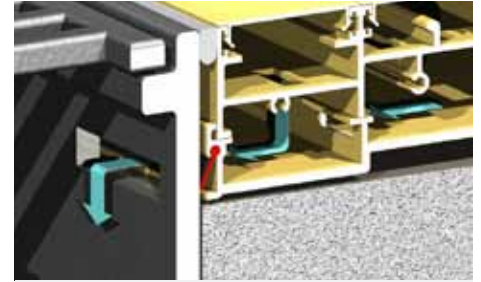

Sill drainage a speciality. Contact AWS Tech Support for varying options.

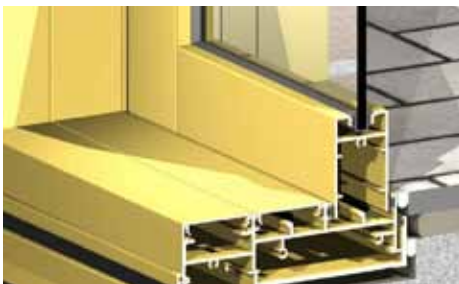

Tall, small, beveled and square rails are all options. Small, square rail illustrated.



Central support leg in sub sill for heavy doors.

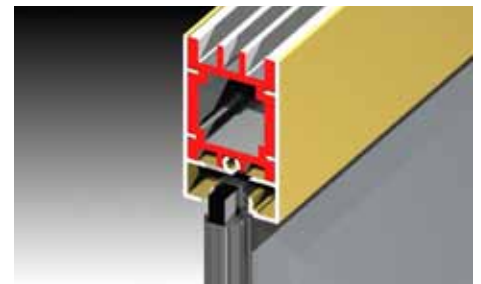

Rails can be stiffened where high wind load is an issue.

Typical Configurations

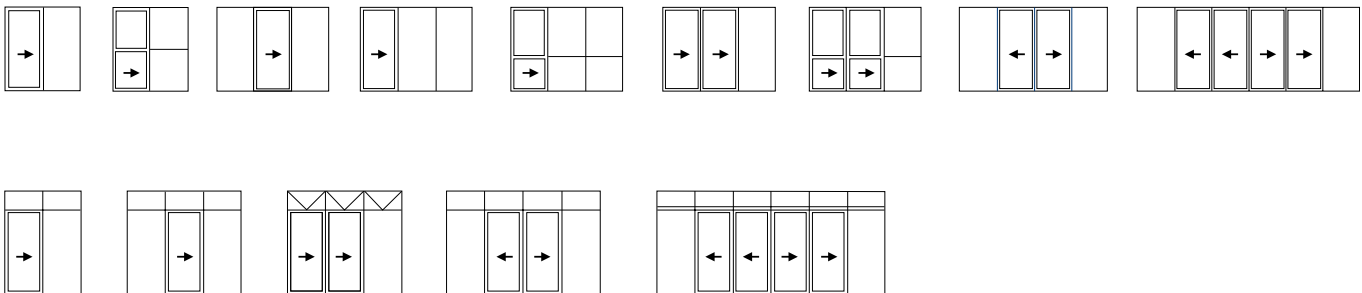

WERS RATINGS

The table below lists some of the WERS rated glass and frame combinations for this system. For a complete list of all rated glass and frame combinations refer to the Series 704 WERS Data Sheet.

Glass Description	Uw	SHGCw	T _w	Inf
6EVanClr	4.62	0.50	0.52	1.12
6EVanSpB	4.62	0.29	0.30	1.12
4/10Ar/4ET	3.28	0.56	0.58	1.12
6.38LamSpGy/12Ar/6	3.88	0.20	0.09	1.12